

CONFIGURATION HANDBOOK

CML100



LOREME 12, rue des Potiers d'Etain Actipole BORNLY - B.P. 35014 - 57071 METZ CEDEX 3
Phone 03.87.76.32.51
Contact : Commercial@Loreme.fr - Technique@Loreme.fr
Download manual at : www.loreme.fr

DEVICE PRESENTATION	p3
FRONT FACE USAGE	p4
Visualization	p4
Configuration	p4
1) Protected configuration access	p4
2) Language	p5
3) NTC parameters (CML100ctn-16 only)	p5
4) Input current scale (CML100mA-16 only)	p5
5) Thermocouple parameters (CML100tc-16 only)	p5
6) Display range (process input only)	p5
7) Alarms (/R option)	p6
8) Relays (/R option)	p7
9) Communication (/CMTCP, /BUS, /CM options).....	p7
10) End of configuration. parameters saving	p8
OFFSET FUNCTION AND CONFIGURATION ACCESS PROTECTION	p9
1) Adjustment of input measure offset	p9
1) Access protection	p9
RS232 LINK SETTING	p10
PC under WINDOWS	p10
FIRMWARE UPDATE	p11
TERMINAL MODE	p12
Visualization	p12
Configuration.....	p12
1) Method	p12
1.1) Menu selection	p12
1.2) Parameter selection	p12
1.3) Value acquisition	p12
2) Configuration items	p12
MEASRE OFFSET	p15
EMC CONSIDERATION	p16
1) Introduction	p16
2) Recommendation of use	p16
2.1) General remarks	p16
2.2) Power supply	p16
2.3) Input / Output	p16
THE RS485 MODBUS COMMUNICATION	p17
1) Feature	p17
2) Response time	p17
3) Data descriptions	p17
BUS100 SYSTEM	p18
THE MODBUS/TCP COMMUNICATION	p19
1) Feature	p19
2) DATA descriptions	p19
3) Table of DATA	p20
3-1) Table of measure in floating format	p20
3-2) Table of measure in integer format	p21
3-3) Table of unit	p22
3-4) Table of alarms	p22
3-5) Table of inverted alarms	p22
WEB SERVER	p23
SNMP	p25
WIRING	p26
DIMENSIONS	p27

Device Presentation

The CML100 is a multichannel analogue signals unit, allowing the acquisition of temperature, process signal or alternating current (via current transformer). A 2 lines LCD display is used to display the measure, alarms and for the configuration of the device.

The input type is define at order. A few models exists:

- CML100t-6-4f** : 6 x 4 wires RTD sensors.
- CML100t-8-3f** : 8 x 3 wires RTD sensors.
- CML100t-16-2f** : 16 x 2 wires RTD sensors.
- CML100ctn-16-2f** : 16 x 2 wires NTC sensors.
- CML100tc-16** : 16 x thermocouples input (J,K,S,T).
- CML100mA-16** : 16 x current 0.4....20 mA inputs.
- CML100V-16** : 16 x voltage 0.....10 Volts inputs.
- CML100j-6-4f** : 6 x strain gauge in 4 wires connexion.
- CML100tiodec** : 16 x small split-core current transformer (Tio-Dc CT).

And each models can have options:

- /R** : 2 alarms relays.
- /CMTCP** : Ethernet MODBUS TCP communication.
- /BUS** : Slave module for a Bus100 system.
- /CM** : RS485 Modbus communication.

The technical data sheet is downloadable here: http://www.loreme.fr/fichtech/CML100_eng.pdf

Bus 100 system : In order to limit the Modbus TCP communication links, the CML100 modules can be connected each other in a bus on DIN rail. This bus is always consist of a master module (/CMTCP) which centralize the measures of the slaves modules (/BUS). This CML100 bus is made up of a maximum of 8 modules (1 master and 7 slaves modules)

USER INTERFACE

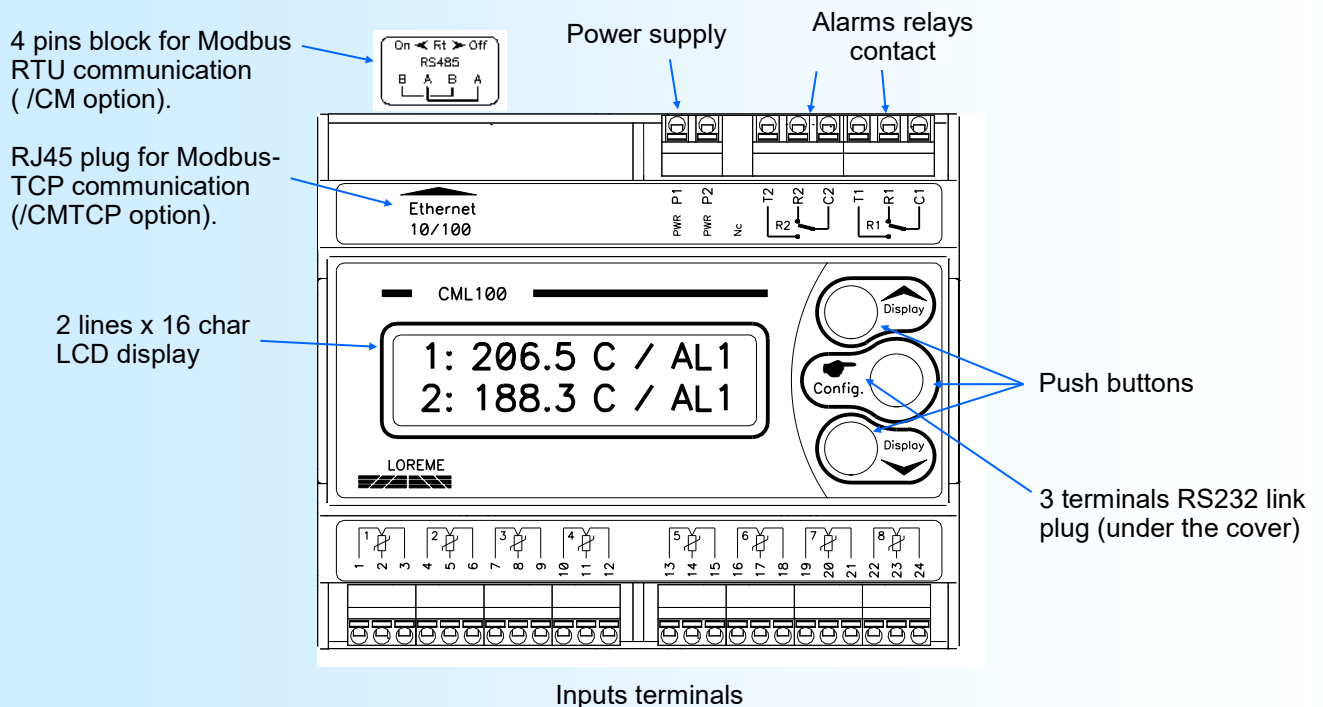

Functions of push buttons:

- ▲ Change of measure page, answer <YES>, increase the display value.
- ▼ Change of measure page, answer <NO>, decrease the display value.
- ⏏ Access to configuration mode, validate the display value.

Front face usage

Visualization

The CML100 display simultaneously 2 channels. The 'Display ▼' and 'Display ▲' buttons allows to scroll the display of measurement channels.

Measures display:

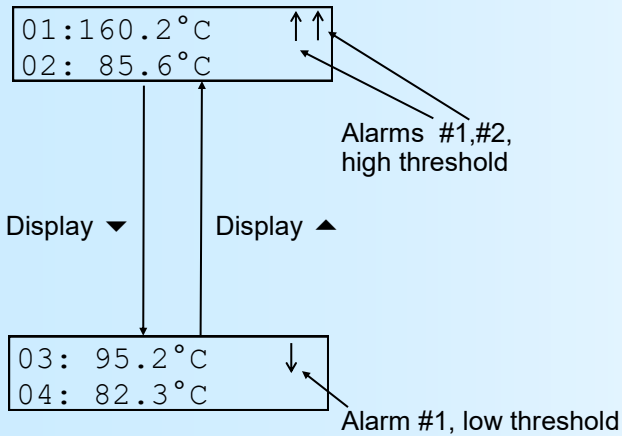

Display with measurements errors:

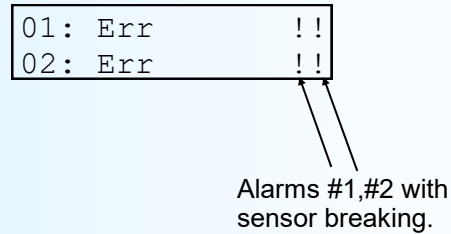

The 'Err' message indicate a sensor breaking error.
 The 'DEFAULT M' indicate a malfunction of input measure circuit of CML100.
 The 'DEFAULT T' indicate a malfunction of the internal temperature sensor on a CML100tc-16.

Remark:

At the power on, and with a CML100 /CMTCP, the following message can be displaying:

```
COMM. DEFAULT
XPORT MODULE
```

This message indicate a default of the internal Ethernet component.

Configuration

The CML100 is fully configurable with the front face. A press on the 'Config' button access to the configuration mode: A temporary message is display to show the device version (Revision Hard and Soft).

```
CONFIGURATION
Rev x.x
```

Depending on the device model and options, some menus are not accessible.

Note : The device leaves the configuration mode if no action are made within 90 seconds. It's only at the end of configuration that new parameters are saved in memory.

1) Protected configuration access

If the « Password » function is activated, entering a code is necessary to access the configuration.

```
PASSWORD?
-----
```

'Display ▲' et 'Display ▼' buttons to change the character.
 (only alphanumeric characters are accepted: '0' to '9' and 'A' to 'Z').
 The 'Config' button validate the character.

A message 'Error !!' is displayed if the password is wrong. The device return to measure mode.

2) language

LANGUAGE? The buttons '▲' and '▼' change the selection.
 <FR> ENG The 'Config' button validate the choice.

- <FR> : French language selected.
- <ENG> : English language selected.

3) NTC parameters (CML100ctn-16-2f only)

For a NTC, the configurable parameters are : the resistance value at 25°C (R0), the B coefficient.
 Reminder, the NTC resistance varies according to the following formula:

$$R_{ntc} = R_0 \times e^{B \times (1/T - 1/T_0)}$$

NTC CONFIG.? Press the 'Display ▲' button (Yes) to access to the NTC parameters
 (Y-N) Press the 'Display ▼' button (No) to skip this menu.

R0 (R AT 25°C) 'Display ▲' to increase or '▼' to decrease the value.
 1.00Mhms 'Config' to validate the value.

B COEFFICIENT 'Display ▲' to increase or '▼' to decrease the value.
 6600 'Config' to validate the value.

4) Input current scale (CML100mA-16 only)

mA INPUT? The buttons '▲' and '▼' change the selection.
 <4/20> 0/20 The 'Config' button validate the choice.

- <4/20> : 4-20mA input scale is selected.
- <0/20> : 0-20mA input scale is selected.

5) Thermocouple parameters (CML100tc-16 only)

INPUT? Press the 'Display ▲' button (Yes) to access to the input parameters.
 (Y-N) Press the 'Display ▼' button (No) to skip this menu.

TC J? The buttons '▲' and '▼' change the selection.
 YES <NO > The 'Config' button validate the choice.

The user can choice between different thermocouples : J, K, S, T or a mV voltage input (0/100 mV).
 The selection is for all 16 channels inputs.

6) Range display (process input only)

The range converts the input signal to a physical quantity. This one facilitates the measures interpreting.

Ex: Input 4-20 mA / Range 0-1000 kg
 → Input = 12 mA, Display = 500 kg

For full range configuration, you need:

- the number of decimals,
- the unit,
- the low scale,
- the high scale.

The decimal number correspond to the number of digit displayed behind the decimal point. This number is limited to 3.

The unit of the display range is useful to interpret the physical measure. It is limited to 4 characters.

RANGE DISPLAY? (Y-N)	Press the 'Display ▲' button (Yes) to access to the display parameters. Press the 'Display ▼' button (No) to skip this menu.
CHANNEL (0, 1..16) ? 0	Select the channels number (here from 1 to 16). The channel '0' is for configuring all channels with the same parameters. Change the value with 'Display ▲' and '▼'. 'Config' to validate the value.
ALL CHANNEL? (Y-N)	Confirmation request for same configuration for all channels. Press the 'Display ▲' (Yes) to confirm. Press the 'Display ▼' (No) to return to the channel selection menu.
NBR OF DECIMAL? 1	Enter the number of decimals. Change the value (from 0 to 3) with 'Display ▲' and '▼'. 'Config' for validate the value.
UNITS? m/s	Unit configuration. (enter the four characters) Change the character value with 'Display ▲' and '▼'. The 'Config' button validate the character and select the next.
LOW SCALE 0m/s	'Display ▲' to increase or '▼' to decrease the value. 'Config' to validate the value.
HIGH SCALE 2200.0m/s	'Display ▲' to increase or '▼' to decrease the value. 'Config' to validate the value.

Note: If the user chose to configure all channels, the device go to next menu. Otherwise it loops back to the menu 'RANGE DISPLAY?' to allow the user to configure another channel.

7) Alarms parameters (/R option)

ALARMS? (Y-N)	Press the 'Display ▲' button (Yes) to access to the alarms parameters. Press the 'Display ▼' button (No) to skip this menu.
CHANNEL (0, 1...8) ? 0	Select the channels number (here from 1 to 8). The channel '0' is for configuring all channels with the same parameters. Change the value with 'Display ▲' and '▼'. 'Config' to validate the value.
ALL CHANNEL? (Y-N)	Confirmation request for same configuration for all channels. Press the 'Display ▲' (Yes) to confirm. Press the 'Display ▼' (No) to return to the channel selection menu.
ALARM #1? (Y-N)	Press the 'Display ▲' button (Yes) to access to the alarms #1 parameters. Press the 'Display ▼' button (No) to skip this menu.
ALARM #2? (Y-N)	Press the 'Display ▲' button (Yes) to access to the alarms #2 parameters. Press the 'Display ▼' button (No) to skip this menu.

The configurable parameter for each alarms are:

- Breaking detection
- Threshold detection

The breaking detection activate the alarm on sensor breaking.
The threshold detection activate alarm on threshold overstepping.

BREAK DETECTION? The buttons '▲' and '▼' change the selection.
 YES <NO> The 'Config' button validate the choice.

THRESHOLD DET.? The buttons '▲' and '▼' change the selection.
 YES <NO> The 'Config' button validate the choice.

For the threshold detection, the configurable parameters are:

- type of detection (Low or High).
- threshold value.
- hysteresis value.

THRESHOLD? The buttons '▲' and '▼' change the selection.
 LOW <HIGH> The 'Config' button validate the choice.

THRESHOLD? 'Display ▲' to increase or '▼' to decrease the value.
 0m/s 'Config' to validate the display value.

HYSTERESIS? 'Display ▲' to increase or '▼' to decrease the value.
 1.0% 'Config' to validate the display value.

The **threshold detection** works in this manner:

- **high threshold** detection:
 - .alarm is activated when measure goes above threshold,
 - .alarm is removed when measure goes below threshold minus hysteresis.
- **low threshold** detection:
 - .alarm is activated when measure goes below threshold,
 - .alarm is removed when measure goes above threshold plus hysteresis.

Notes:

- The unit of hysteresis value is model dependent. For a CML100 with process input, the hysteresis is display in percent (%) of the display range. For a CML100 with temperature inputs, the hysteresis is display in °C.
- If the user chose to configure all channels, the device go to next menu. Otherwise it loops back to the menu 'ALARMS?' to allow the user to configure another channel.

8) Relays (/R option)

With the /R option, the CML100 have 2 relays associated respectively with alarms #1 and #2 for all channels (OR function between alarms). For each relays, the configurable parameters are the security and the delay.

The delay (configurable from 2s to 3600s) is the period of time between the appearing of event and the action on relay.

RELAY 1? Press the 'Display ▲' button (Yes) to access to the relay #1 parameters.
 (Y-N) Press the 'Display ▼' button (No) to skip this menu.

RELAY 2? Press the 'Display ▲' button (Yes) to access to the relay #2 parameters.
 (Y-N) Press the 'Display ▼' button (No) to skip this menu.

parameters:

DELAY? 'Display ▲' to increase or '▼' to decrease the value.
 2s 'Config' to validate the display value.

SECURITY? The buttons '▲' and '▼' change the selection.
 <POS.> NEG. The 'Config' button validate the choice.

For the security parameter, two choice are available:
 -<POS.> Positive security. The relay is activated on alarm.
 -<NEG.> Negative security. The relay is activated off alarm.

9) Communication (/CMTCP or /BUS or /CM option)

COMMUNICATION? Press the 'Display ▲' button (Yes) to access to the communication parameters.
 (Y-N) Press the 'Display ▼' button (No) to skip this menu.

Parameters for a CML100xxx/CMTCP:

IP ADDRESS? 'Display ▲' and 'Display ▼' to modify the IP address fields.
 192.168.000.253 The 'Config' button is use to validate the field.

IP MASK? 'Display ▲' and 'Display ▼' to modify.
 255.255.255.000 'Config' button to validate.
 by default, the IP address is 192.168.0.253, and 255.255.255.0 for mask.

Parameters for a CML100xxx/BUS:

BUS ADDRESS? 'Display ▲' to increase or '▼' to decrease the value.
 1 'Config' to validate the display value.

This address is configurable from 1 to 8. By default, the BUS address is 1.
 Refer to « Bus100 system » for more explanations.

Parameters for a CML100xxx/CM:

BAUDRATE (Kbds) ? The buttons '▲' and '▼' change the selection.
 <9.6> 19.2 The 'Config' button validate the choice.

STOP BIT? The buttons '▲' and '▼' change the selection.
 <1 > 2 The 'Config' button validate the choice.

ADDRESS? 'Display ▲' for increase or '▼' for decrease the value.
 1 'Config' to validate the display value.

The default parameters are : 9.6 Kbauds, 1 Stop bit, address: 1

10) End of configuration. Parameters saving

MEMORIZING This message is display only when the user enter in COMMUNICATION menu on a
 ***** CML100 / MTCP.

OK This message indicate the end of configuration and that the parameters are saved
 in memory.

1) Setting of measure input offset

It is possible to adjust the inputs measure by the offset value.

1.1) Activating the function

When the device is in measure mode, pressing simultaneously on '▲' and '▼' buttons for at least 5 seconds, the following message is displayed:

OFFSET?	The buttons '▲' and '▼' change the selection.
<YES> NO	Validate the choice with "Config" button.
CHAN.NB (0:ALL) ?	Set the channel number for the input. Use buttons to set the offset value. For adjust the offset for all inputs, set the number to 0.
0	
1: 99.9°C	The first line display the input measurement.
OFS: -5	The second line display the offset value (in analog/digital conversion point). The buttons ▲ and ▼ are used to change the value. Validate with the "Config" button.
OTHER CHANNEL ?	Select "NO" to quit the setting mode.
YES <NO >	Select "YES" to adjust another input channel.

If no action taken within 1 minute, the device return automatically to measure mode and discard any changes.

2) Configuration access protection

It is possible to forbid the access to the configuration's device. When the "Password" function is activated, the user must enter a 4 characters code to access in configuration mode.

2.1) Activation the function

When the device operate in measure mode, pressing simultaneously

OFFSET?	The buttons '▲' and '▼' change the selection.
YES <NO >	The 'Config' button validate the choice.
	=> Answer NO to access to the password.

PASSWORD?	The buttons '▲' and '▼' change the selection.
YES <NO >	The 'Config' button validate the choice.

- <NO> : deactivating the "Password" function. Access to configuration mode is free.
- <YES> : activating the function.

PASSWORD?	Enter a new code:
----	'Display ▲' et 'Display ▼' buttons to change the character.
	(only alphanumeric characters are accepted: '0' to '9' and 'A' to 'Z').
	The 'Config' button validate the character.

Note: When activating the function by answering YES, a new code is automatically requested.

RS232 link setting

The device can be configured or updated in terminal mode via an RS232 link.

Step 1: Driver installation for USB / RS232 adapter



- download driver at www.loreme.fr:
http://www.loreme.fr/aff_produits.asp?rubid=53&langue=fr
- Click on executable file to install the driver,
- Plug the cable on a USB port, Windows install a new serial communication port **COMx** (x >= 4).

Note :

The use of the cable on another USB port don't generates a new communication port. Use of another adapter generates another communication port number (COMx) and requires the reconfiguration of the HyperTerminal.

Step 2: Setting of terminal emulation software (PC with windows).

1 The terminal emulation software for PC « HyperTerminal » is resident in windows up to XP version. For later versions, it is downloadable on : www.loreme.fr in **download part** (<http://www.loreme.fr/HyperTerm/htpe63.exe>)
=> Run the downloaded software to install it.

2 Start a "hyper Terminal" connection :
- Click on **"START"** button
Up to XP version
- Go to **"Programs \ Accessories \ Communication \ Hyper Terminal"**
- Click on **"Hypertrm.exe"**
Or if the software was downloaded
- Go to **"All programs \ HyperTerminal Private Edition"**
- Click on **"HyperTerminal Private Edition"**

3 Enter name for the new connection

4 Choose the communication port related to the adapter.

5

Choose:
- 9600 bauds
- 8 DATA bits
- no parity
- 1 stop bit
- **XON/XOFF**

6 The PC is now in terminal mode, connect it to the device by plugging the RS232 cable. The measure is now displayed on the terminal. To access configuration, press 'C' key.

7 When leaving Hyper terminal, the following window will appear. By saving, the terminal session will start with the same configuration.

Thus, the shortcut  **LOREME.ht** will permit to communicate with all LOREME devices.

Note: To modify the parameters of terminal session whereas this one is connected, it is necessary to disconnect it, modify the parameters and then to reconnect it.

FIRMWARE update

To access to the firmware update function, you must first open an HyperTerminal session on a PC, connect the device to the PC with the RS232 link cable and then power on the device.

The following character is send to the terminal:

> <————— The device sends this character then it waits the « F » key during 0.5 s.

If the user has pressed the « F » key in the allowed time, the following message is displayed in the HyperTerminal windows:

**FIRMWARE LOADER Rev2.1
READY TO TRANSFER...**

The device is now in the firmware load mode and is waiting for the firmware file. This file is provide by LOREME and contain the firmware code in Intel HEX format.

Select the « Transfer », « Send a text file ... » in the HyperTerminal menu.
Select the directory and open the file. The HyperTerminal program begins to send the file to the device.

**FIRMWARE LOADER Rev2.1
READY TO TRANSFER**

***** <————— The star characters appears to show the progress of the uploading.

At the end, the message « **PROGRAMMING OK !** » is display if no errors occurs. Otherwise, these following message could be displayed:

- **SERIAL COM ERROR !** Error during receipt.
- **SERIAL TIMEOUT !** Waiting time of receipt elapsed (60 s).
- **PROGRAMMING FAILED !** Programming error in the internal flash memory.

Attention

*If an error occurs during the programming process, it is necessary to start again the whole procedure.
A bad programming leads to an inoperative device.*

RANGE DISPLAY?
(Y-N)

Configuration of display range for a CML100 with process inputs.

The following page could be display (here for a CML100V-16) when you access to this rubric:

```

CHANNEL?      V01 0/10V      0/500.0 kg
0,1....16    V02 0/10V      0/10.00 V
<ENTER>      V03 0/10V      0/10.00 V
->           V04 0/10V      0/10.00 V
0:ALL CHANNEL V05 0/10V      0/10.00 V
SELECTION     V06 0/10V      0/10.00 V
              V07 0/10V      0/10.00 V
              V08 0/10V      0/10.00 V
              V09 0/10V      0/10.00 V
              V10 0/10V      0/10.00 V
              V11 0/10V      0/10.00 V
              V12 0/10V      0/10.00 V
              V13 0/10V      0/10.00 V
              V14 0/10V      0/10.00 V
              V15 0/10V      0/10.00 V
              V16 0/10V      0/10.00 V
    
```

Channel number (points to V01), input range (fixed according to the CML100 inputs) (points to 0/10V), Display range (points to 0/500.0 kg), Display unit (points to kg)

LEAVE

Press <L>

To change the input parameters for the channel, enter the channel number and press <Enter>. The number '0' is for a configuration for all channel. Press <L> to quit the display range configuration.

- Configurable parameters are:
- The number of decimal,
 - The unit,
 - The low and high scale.

ALARMS CONFIGURATION?
(Y-N)

This page is displayed when the alarm configuration is access:

```

CHANNEL?      V01 55.0/1.0 °C      HIGH!
0,1....8      V02 OFF!
<ENTER>      V03 OFF
->           V04 OFF
0:ALL CHANNEL V05 OFF
SELECTION     V06 OFF
              V07 OFF
              V08 OFF
    
```

THRESHOLD1/HYSTERESIS (points to 55.0/1.0 °C), HIGH! (points to HIGH!), Threshold detection not activated (points to OFF!), Breaking sensor detection activated (points to OFF!), Type of detection (points to OFF!), Breaking sensor detection activated (points to OFF!), LOW! (points to LOW!)

LEAVE
Press <L>

To change the alarm parameters for the channel, enter the channel number and press <Enter>. The number '0' is for a configuration for all channel. Press <L> to quit the alarm configuration.

For each alarms, the configurable parameters are: - Breaking detection
 - Threshold detection

For the threshold detection, the parameters are: - type of detection (Low or High).
 - threshold value.
 - hysteresis value.

RELAY 1? Access to the relays #1 configuration (delay, security).
(Y-N)

RELAY 2? Access to the relays #2 configuration (delay, security).
(Y-N)

COMMUNICATION? Access to the communication configuration.
(Y-N)

Option /CMTCP:
IP ADDRESS Configure the Ethernet parameter (IP address and mask).
192.168.000.253

IP MASK Each field must have 3 digits. The separator character is automatically insert.
255.255.255.000

Option /BUS:
BUS ADDRESS Configuration of module address on the BUS100.
4

Option /CM:
ADDRESS Configuration of modbus slave address.
2

BAUDRATE (Kbds) : 9.6 Configuration of communication baud rate.
(Y-N)NO
or
BAUDRATE (Kbds) : 19.2
(Y-N)NO

1 STOP BIT? Configuration of number of stop bit
(Y-N)YES
or
2 STOP BIT?
(Y-N)NO

MEMORIZING Message when Ethernet communication parameters are saved.

OK End of configuration. The parameters are saved in memory.

MEASURE OFFSET

In some case, it is interesting to adjust the measure. This function can be useful in case such as sensor aging, input adjustment etc..

This function is available for all inputs or individually.

Press the "+" or "-" keys to access to offset function,

In the terminal, the display looks like:

NB CHAN.(0:ALL)?

2

Enter the channel number or "0" for all channels.

2: 105.2 °C

OFS: 10

Number of channel, measure input with offset.
offset value in analog/digital points.

- Use the "+" and "-" to set offset,
- Use the "ENTER" key to validate the change.

**OTHER CHANNEL?
(Y-N)**

Type on "Y" for adjust an another channel offset
or "N" to ending function.

Remarque

When the device is power off, the input offset remain active.

To cancel the offset of a channel, you should enter in offset function and set the offset value to 0.

If in offset setting, no action is carried out for a period of 1 minute, the device automatically return to measure mode and discard any change.

EMC Consideration

1) Introduction

To meet its policy concerning EMC, based on the Community directives **2014/30/EU** & **2014/35/EU**, the LOREME company takes into account the standards relative to this directives from the very start of the conception of each product.

The set of tests performed on the devices, designed to work in an industrial environment, are made in accordance with **IEC 61000-6-4** and **IEC 61000-6-2** standards in order to establish the EU declaration of conformity. The devices being in certain typical configurations during the tests, it is impossible to guarantee the results in every possible configurations. To ensure optimum operation of each device, it would be judicious to comply with several recommendations of use.

2) Recommendations of use

2.1) General remarks

- Comply with the recommendations of assembly indicated in the technical sheet (direction of assembly, spacing between the devices, ...).
- Comply with the recommendations of use indicated in the technical sheet (temperature range, protection index).
- Avoid dust and excessive humidity, corrosive gas, considerable sources of heat.
- Avoid disturbed environments and disruptive phenomena or elements.
- If possible, group together the instrumentation devices in a zone separated from the power and relay circuits.
- Avoid the direct proximity with considerable power distance switches, contactors, relays, thyristor power groups, ...
- Do not get closer within fifty centimeters of a device with a transmitter (walkie-talkie) of a power of 5 W, because the latter can create a field with an intensity higher than 10 V/M for a distance fewer than 50 cm.

2.2) Power supply

- Comply with the features indicated in the technical sheet (power supply voltage, frequency, allowance of the values, stability, variations ...).
- It is better that the power supply should come from a system with section switches equipped with fuses for the instrumentation element and that the power supply line be the most direct possible from the section switch.
- Avoid using this power supply for the control of relays, of contactors, of electrogates, ...
- If the switching of thyristor statical groups, of engines, of speed variator, ... causes strong interferences on the power supply circuit, it would be necessary to put an insulation transformer especially intended for instrumentation linking the screen to earth.
- It is also important that the installation should have a good earth system and it is better that the voltage in relation to the neutral should not exceed 1V, and the resistance be inferior to 6 ohms.
- If the installation is near high frequency generators or installations of arc welding, it is better to put suitable section filters.

2.3) Inputs / Outputs

- In harsh conditions, it is advisable to use sheathed and twisted cables whose ground braid will be linked to the earth at a single point.
- It is advisable to separate the input / output lines from the power supply lines in order to avoid the coupling phenomena.
- It is also advisable to limit the lengths of data cables as much as possible.

RS485 MODBUS communication

1) Features

Protocol:	MODBUS RTU
Link:	RS485
Baud rate:	9600 or 19200 bauds (9600 bauds by default)
Default address:	1
Number of stop bit:	1 or 2 (1 by default)
Connector:	spring connector
Read request:	Function code 03,04
Write request:	No supported
Type of data:	Inputs measure, unit, state of alarms.
Data format:	Measure values in IEEE 32 bits floating format or 16 bits signed integer. ASCII for unit characters. 16 bits for alarms status.

2) Response time

The response delay to a read request is from 20 ms to 200 ms.

3) Data description

The format and the location of data are the same as the MODBUS TCP data.

The data are accessible from address 0 to 83 (0x0053 hexa) for each slave. Meaning a total of 84 registers.

BUS100 System

The BUS100 is a modular system composed of one master (/CMTCP module. Module with Ethernet link) and slaves modules (/BUS model without Ethernet link). All modules are reachable by the Ethernet link. Each module is accessible via its own address range. The master module is always accessible in the address range of 0 to 999. The slaves module (/BUS module) are reachable in an address range equal to **1000 x BUS address**. The address parameter is configurable by the front face of device and should be different for each BUS module connected as shown below.

Example of a BUS system

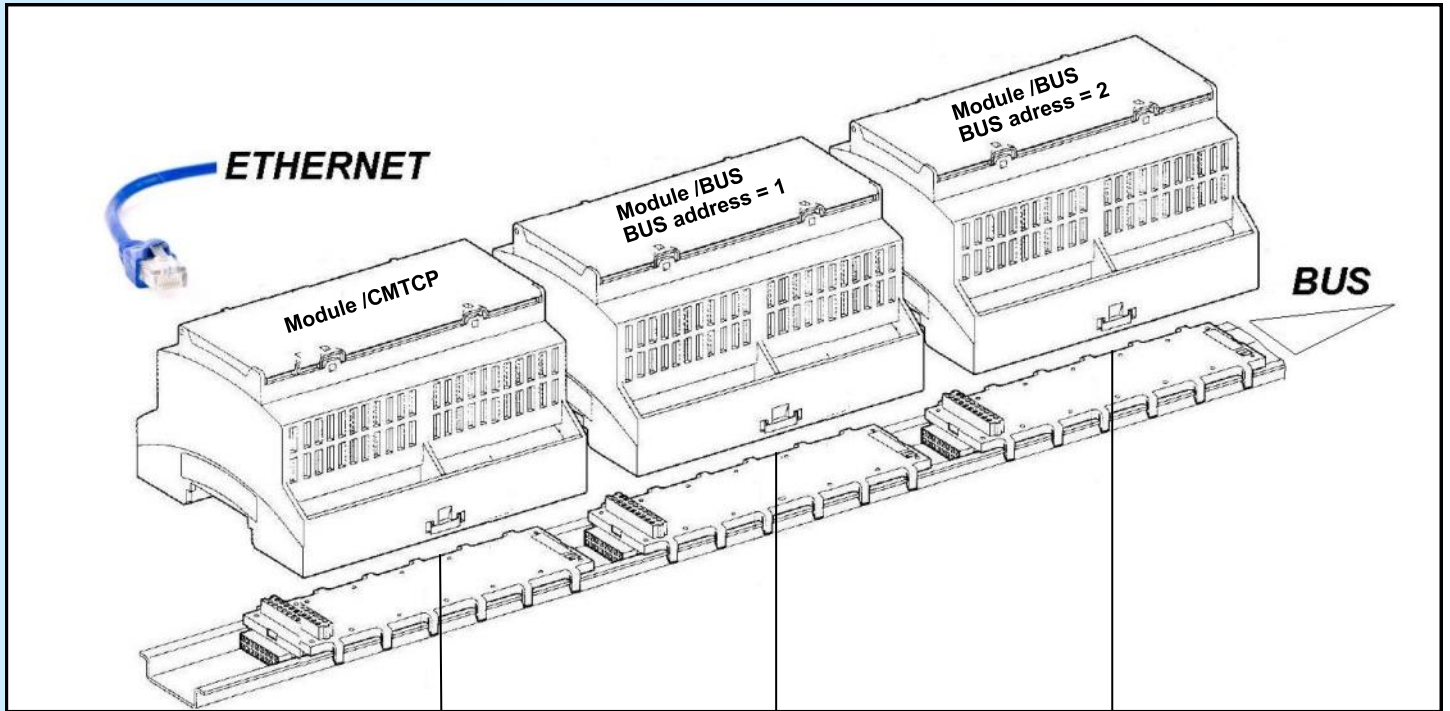

Possible address range		Possible address range		Possible address range	
from	0000	from	1000	from	2000
	Range of measure registers		Range of measure registers		Range of measure registers
	<i>(The length of this range depends on the type of device)....</i>		<i>(The length of this range depends on the type of device)....</i>		<i>(The length of this range depends on the type of device)....</i>

	Reserved address for the configuration		Address reserved for the configuration		Address reserved for the configuration

to	0999 Reserved address for a device identification code	to	0999 Reserved address for a device identification code	to	0999 Reserved address for a device identification code

Reserved address for later use.

MODBUS TCP communication

1) feature

Firmware revision: 08
 Protocol: MODBUS TCP
 Link: Ethernet 10/ 100 base T
 IP address by default: 192.168.0.253
 Port: 502
 Connector: RJ45
 Read request: Function code 03,04
 Write request: Not supported
 Type of data: Inputs measure, unit, state of alarms.
 data format: Measure values in IEEE 32 bits floating format or 16 bits signed integer. ASCII for unit characters. 16 bits for alarms status.

Note: The CML100/CMTCP can have up to 6 connexions simultaneously. It also incorporates a web server that allows the viewing of measurements and alarms.

2) Data description

2.1) Data available

All measures are reachable in reading mode. Data are available in different formats:

- 2 words or 4 bytes for measure in IEEE 32bits floating format,
- 2 words or 4 bytes for unit characters (4 ASCII characters),
- 1 word or 2 bytes for alarms status (1 word per alarm),
- 1 word or 2 bytes for measure in signed 16bits integer format,
- 1 word or 2 bytes for inverted alarms status (1 word per alarm).

2.2) Data format

- Data in 32 bits IEEE floating point format (measures)
 Data are transmitted Most Significant Byte first, 4 bytes or 2 words long.
 \$FFFFFFF = sensor braking or unused channel.

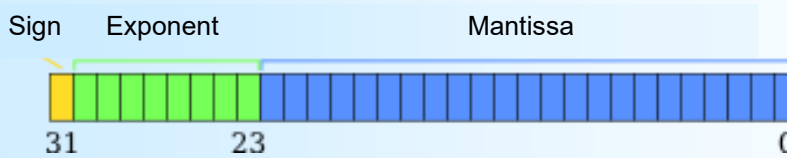

- Data in 16 bits signed integer.
 - Data are transmitted Most Significant Byte first.
 The value is the measure x 10
 \$7FFF = sensor braking or unused channel.

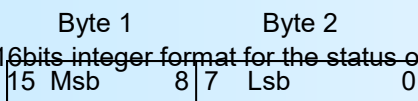

- Data in 16bits integer format for the status of alarm 1 or 2. One bit per channel and 1 word per alarm.

- | | |
|---------------------------|-------------------------|
| Bit 15 : alarm channel 16 | Bit 7 : alarm channel 8 |
| Bit 14 : alarm channel 15 | Bit 6 : alarm channel 7 |
| Bit 13 : alarm channel 14 | Bit 5 : alarm channel 6 |
| Bit 12 : alarm channel 13 | Bit 4 : alarm channel 5 |
| Bit 11 : alarm channel 12 | Bit 3 : alarm channel 4 |
| Bit 10 : alarm channel 11 | Bit 2 : alarm channel 3 |
| Bit 9 : alarm channel 10 | Bit 1 : alarm channel 2 |
| Bit 8 : alarm channel 9 | Bit 0 : alarm channel 1 |

Remark: On device model with 6 or 8 channels, the unused bits stay to "0".

Note: For /BUS mode, the addresses are shifted by 1000 at bus address.
 For example, a module with a bus address 5000 have measures registers reachable from 5000 (\$1388 hexa) to 5030 (\$13A6), from 5032 (\$13A8) to 5062 (\$13C6) for units, from 5064 (\$13C8) to 5065 (\$13C9) for alarms, from 5066 (\$13CA) to 5081 (\$13D9) for measure in 16bits integers, from 5082 (\$13DA) to 5083 (\$13DB) for inverted alarms.

3) Table of DATA

3-1) Table of measure in 32bits floating format

Register address in decimal (in Hexadecimal)	Designation		Total words
0000 (\$0000)	Measure of Channel 1	Word 1	1
	(floating IEEE)	Word 2	2
0002 (\$0002)	Measure of Channel 2	Word 1	3
	(floating IEEE)	Word 2	4
0004 (\$0004)	Measure of Channel 3	Word 1	5
	(floating IEEE)	Word 2	6
0006 (\$0006)	Measure of Channel 4	Word 1	7
	(floating IEEE)	Word 2	8
0008 (\$0008)	Measure of Channel 5	Word 1	9
	(floating IEEE)	Word 2	10
0010 (\$000A)	Measure of Channel 6	Word 1	11
	(floating IEEE)	Word 2	12
0012 (\$000C)	Measure of Channel 7	Word 1	13
	(floating IEEE)	Word 2	14
0014 (\$000E)	Measure of Channel 8	Word 1	15
	(floating IEEE)	Word 2	16
0016 (\$0010)	Measure of Channel 9	Word 1	17
	(floating IEEE)	Word 2	18
0018 (\$0012)	Measure of Channel 10	Word 1	19
	(floating IEEE)	Word 2	20
0020 (\$0014)	Measure of Channel 11	Word 1	21
	(floating IEEE)	Word 2	22
0022 (\$0016)	Measure of Channel 12	Word 1	23
	(floating IEEE)	Word 2	24
0024 (\$0018)	Measure of Channel 13	Word 1	25
	(floating IEEE)	Word 2	26
0026 (\$001A)	Measure of Channel 14	Word 1	27
	(floating IEEE)	Word 2	28
0028 (\$001C)	Measure of Channel 15	Word 1	29
	(floating IEEE)	Word 2	30
0030 (\$001E)	Measure of Channel 16	Word 1	31
	(floating IEEE)	Word 2	32

3-2) Table of measures in signed 16bits integer

Register address in decimal (in Hexadecimal)	Designation		Total words
0066 (\$0042)	Channel 1, measure x 10	Word 1	1
0067 (\$0043)	Channel 2, measure x 10	Word 1	2
0068 (\$0044)	Channel 3, measure x 10	Word 1	3
0069 (\$0045)	Channel 4, measure x 10	Word 1	4
0070 (\$0046)	Channel 5, measure x 10	Word 1	5
0071 (\$0047)	Channel 6, measure x 10	Word 1	6
0072 (\$0048)	Channel 7, measure x 10	Word 1	7
0073 (\$0049)	Channel 8, measure x 10	Word 1	8
0074 (\$004A)	Channel 9, measure x 10	Word 1	9
0075 (\$004B)	Channel 10, measure x 10	Word 1	10
0076 (\$004C)	Channel 11, measure x 10	Word 1	11
0077 (\$004D)	Channel 12, measure x 10	Word 1	12
0078 (\$004E)	Channel 13, measure x 10	Word 1	13
0079 (\$004F)	Channel 14, measure x 10	Word 1	14
0080 (\$0050)	Channel 15, measure x 10	Word 1	15
0081 (\$0051)	Channel 16, measure x 10	Word 1	16

3-3) Table of units

Register address in decimal (in Hexadecimal)	Designation	Total words
0032 (\$0020)	Unit channel 1, (4 ASCII characters)	Word 1 Word 2 1 2
0034 (\$0022)	Unit channel 2, (4 ASCII characters)	Word 1 Word 2 3 4
0036 (\$0024)	Unit channel 3, (4 ASCII characters)	Word 1 Word 2 5 6
...
...
0060 (\$003C)	Unit channel 15, (4 ASCII characters)	Word 1 Word 2 29 30
0062 (\$003E)	Unit channel 16, (4 ASCII characters)	Word 1 Word 2 31 32

The unit is a string of 4 ASCII characters. If the unit is formed by less than 4 characters, the string is terminated with the value 0.

Example: The unit of channel 1 is "mA". The 4 characters read from address 32 will be:
Byte 1 = 109, Byte 2 = 65, Byte 3 = 0, Byte 4 = 0. This corresponds to the ASCII code for "mA".

3-4) Table of normal alarms

Register address in decimal (in Hexadecimal)	Designation	Total words
0064 (\$0040)	Alarm #1 (channel 1 to 16)	Word 1 1
0065 (\$0041)	Alarm #2 (channel 1 to 16)	Word 1 2

3-5) Table of inverted alarms

Register address in decimal (in Hexadecimal)	Designation	Total words
0082 (\$0052)	Inverted Alarm #1 (channel 1 to 16)	Word 1 1
0083 (\$0053)	Inverted Alarm #2 (channel 1 to 16)	Word 1 2

Note : The status of the bits indicate the status of the alarms.
bit0 = alarm channel 1 ,..., bit15 = alarm channel 16

WEB Server

Details of the WEB page

This page consist of a banner showing the status of modules, a page showing the measure values of the selected module and two icons for commands.

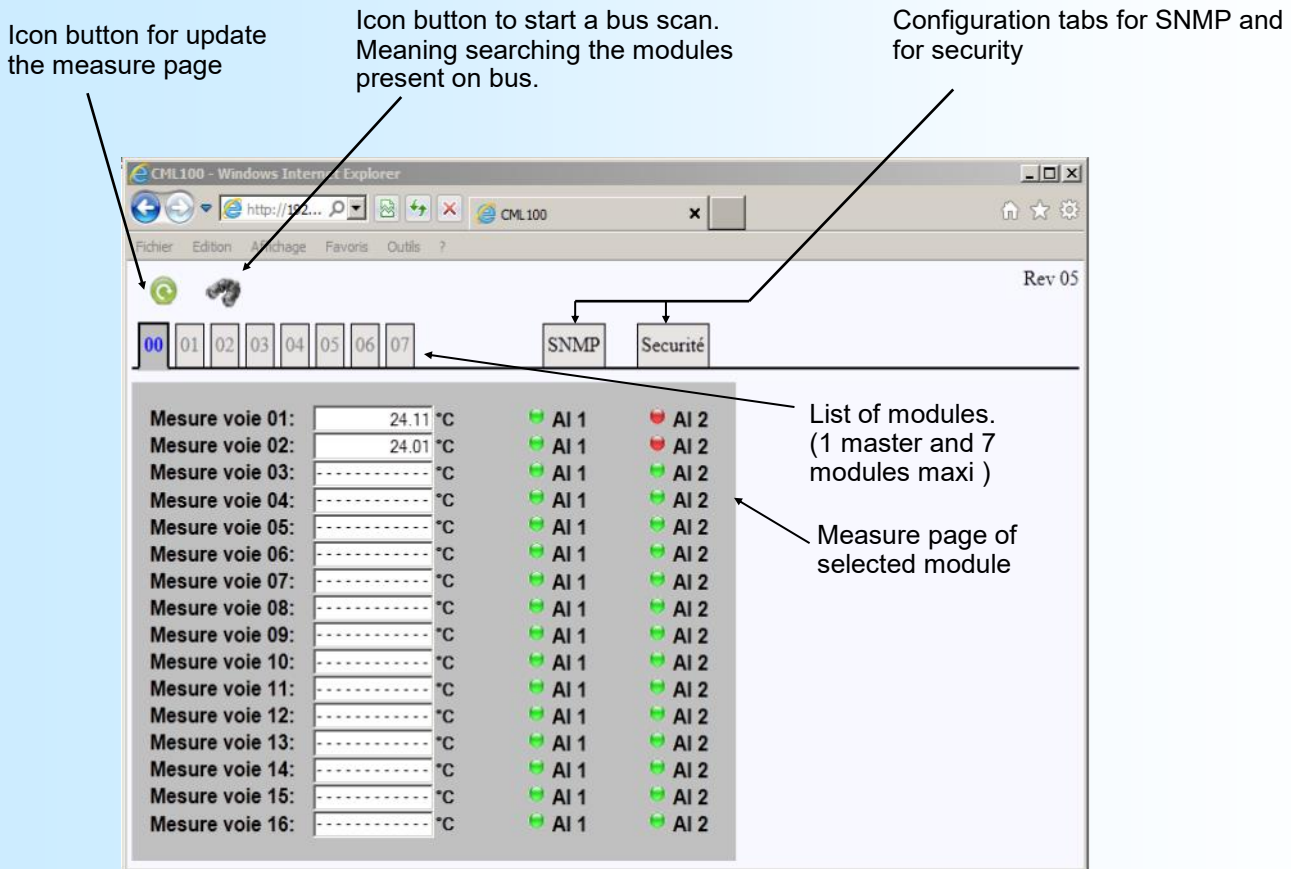

Overview of present or absent modules

In this banner, each tab represent one module. The address of module present on the bus are display in green. The address of module absent are display in grey and are not accessible. The tab "0" is always the master module (/CMTCP) and the tab 1 to 7 are for the slave modules (/BUS).

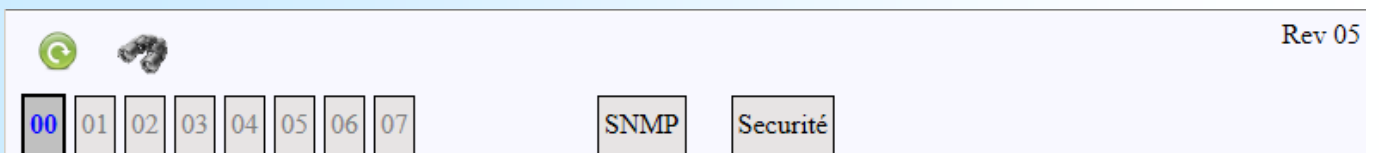

The Bus Scan

At the power on, the CML100/MTCP scan the internal bus to discover the address of modules who are present. It is possible to the user to restart a scan at any time by click on button (useful if the bus composition was changed.)

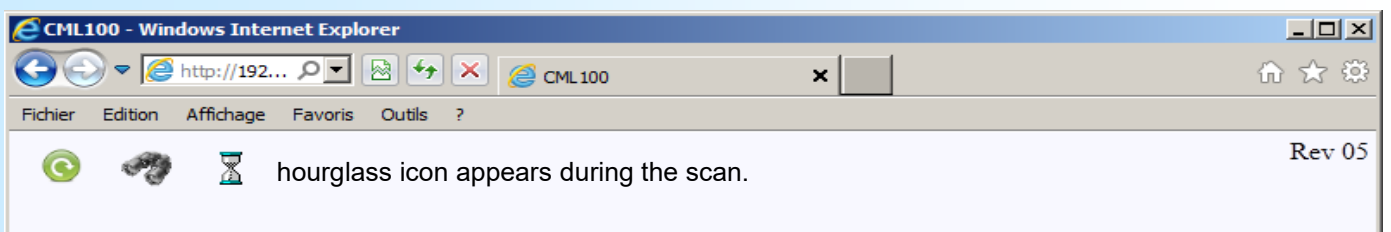

Measure page of a module

After the selection of tab corresponding to the module address, the measure page is refreshed. The refresh is not automatic. The user must click on icon button.

The CML100 have a measure table for 16 channels maximum. The channels who are not physically present are grayed out. A measure display of '-----' indicated a channel unused or a breaking sensor condition on channel.

Page example for a CML100t-8-3F (8 x 3 wires PT100 inputs):

Channel present on device.	Mesure voie 1 :	-----	°C	🔴 AI 1	🔴 AI 2	Both the alarms of channel are activated.
	Mesure voie 2 :	-----	°C	🔴 AI 1	🔴 AI 2	
	Mesure voie 3 :	84.87	°C	🟢 AI 1	🟢 AI 2	Alarms not activated.
	Mesure voie 4 :	95.96	°C	🟢 AI 1	🔴 AI 2	
	Mesure voie 5 :	85.38	°C	🟢 AI 1	🔴 AI 2	
	Mesure voie 6 :	4.27	°C	🟢 AI 1	🟢 AI 2	
	Mesure voie 7 :	-----	°C	🔴 AI 1	🔴 AI 2	
	Mesure voie 8 :	-----	°C	🔴 AI 1	🔴 AI 2	
Channel not physically present on device.	Mesure voie 9 :	-----		⊖ AI 1	⊖ AI 2	
	Mesure voie 10 :	-----		⊖ AI 1	⊖ AI 2	
	Mesure voie 11 :	-----		⊖ AI 1	⊖ AI 2	
	Mesure voie 12 :	-----		⊖ AI 1	⊖ AI 2	
	Mesure voie 13 :	-----		⊖ AI 1	⊖ AI 2	
	Mesure voie 14 :	-----		⊖ AI 1	⊖ AI 2	
	Mesure voie 15 :	-----		⊖ AI 1	⊖ AI 2	
	Mesure voie 16 :	-----		⊖ AI 1	⊖ AI 2	

Modify the BUS composition

It is best to turn off the rail when a module is added or removed.

Important

After a scan, make sure that all modules present on the bus are properly displayed as present on the web page. If this is not the case, restart a scan.

Because for any module detected as missing after the scan whereas there are physically present will be considered absent for the Modbus TCP communication!.

=> This scenario can happen if a module is in configuration mode during the scan..

SNMP

1) General information's

SNMP (Simple Network Management Protocol) is the most widely used protocol for managing network devices. It is based on UDP protocol and provides the control code transmission and reception of response between different network devices. It is based on two main elements: a manager (which generates commands and receives the response messages) and agents (that answer to commands and can generate messages). To communicate with the different agents, the manager use a database (MIB) dedicated to this agent. This MIB forms a tree structure that includes various accessible parameters of the agent. To access a data item, the manager must know the location of this item in the MIB tree. This location (OID) is represented by a sequence of numbers separated by dots.

The manager sends request to agents by the UDP port 161. This requests therefore contain the OID (the path) of the parameter and the type of action to perform (read or write). But an agent can also sends message (traps) on UDP port 162. This traps are alert messages issued by agent to the SNMP manager to report abnormal events.

2) Use

The CML100 is a SNMPv1 agent. The type and the format of data that is accessed through SNMP correspond to the measure value x 10 in signed 16bits integer, and alarms status. The /SNMP option is not compatible with the BUS100 system.

The CML100 can generate traps to the activation of alarm relays.

The SNMP configuration parameters are accessible only by the WEB page. This configuration page can be protected by a password.

This SNMP parameters include the SNMP manager IP address (the recipient of traps messages), the community names (by default the read community is « public » and the write community is « private »). For disable the traps just put 0.0.0.0 for the recipient IP address.

3) MIB file

The MIB file can be downloaded directly on the « SNMP » web page.

4) Password protection

Go to « Security » tab and activate the password. Enter the new password and confirm it. Memorized the change with the « save » button.

At this moment, it is mandatory to enter the password before storing the changes with the « save » button. It is still possible to disable or to modify the password. After each reactivation of password, you must enter a new password because the old one is not preserved.

If the password is forgotten: in the « security » tab, enter « loreme » as the password and save it.

Wirings

PC - DEVICE LINK

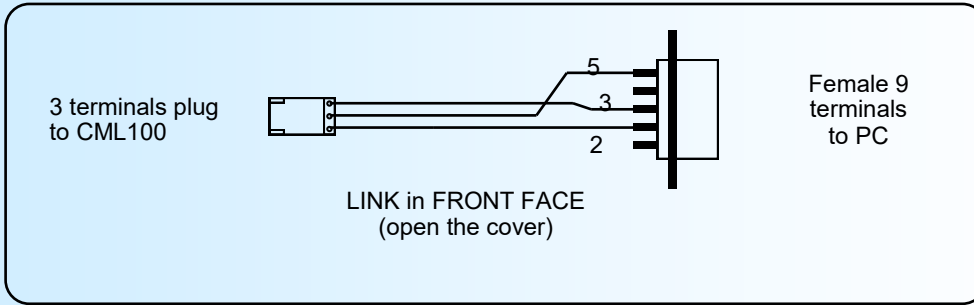

DIAGRAMS OF CONNECTIONS

/CM option
With switch for termination resistance (Rt)



/CMTCP option

Cover (lift here)

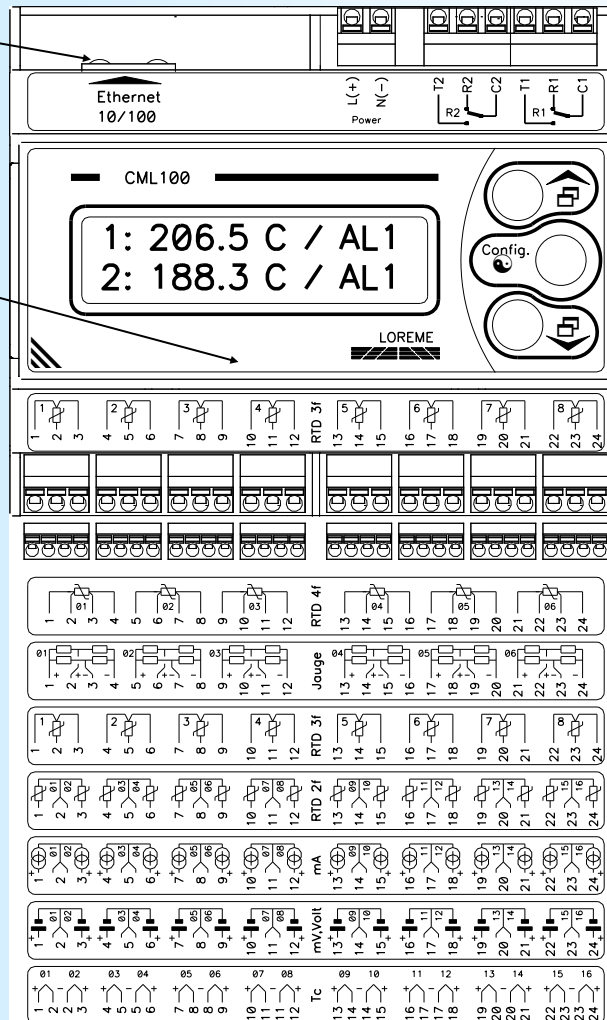

P1, P2: Power supply

T2: NO Contact relay #2
R2: NC Contact relay #2
C2: Common Contact relay #2

T1: NO Contact relay #1
R1: NC Contact relay #1
C1: Common Contact relay #1

Wiring for 6 x 4 wires RTD

Wiring for 6 x 4 wires strain gauge

Wiring for 8 x 3 wires RTD

Wiring 16 x 2 wires RTD

Wiring 16 x current (mA) inputs

Wiring 16 x voltage (V) inputs

Wiring 16 x thermocouple

Channel 1

Channel 6, 8 or 16

Outline dimensions

